

10th call for proposals - HED instrument -

**Closes Friday, 09 December 2022,
at 16:00**

(local Hamburg/Schenefeld time / Central European Time – CET)

Submit via web portal:

<https://in.xfel.eu/upex>

Never been at HED? No problem: look at our hutch using

[the virtual tour \(link\)!](#)

Unique capabilities arise when:

Couple XFEL beam to powerful drivers

□ Diamond Anvil Cells **HiBEF**

dynamic DAC; pulsed laser heated DAC; double-stage DAC

□ Powerful optical lasers

100 J 15 ns 10 Hz (DiPOLE); 400 TW 30 fs 10 Hz (ReLaX) **HiBEF**
0.2 – 2 J 15 fs 800 nm 1 MHz; 1– 40 mJ 800 fs 1 MHz (pp-laser)

□ XFEL split&delay line (2023+)

x-ray pump-probe, 0-20 ps delay



Bundesministerium
für Bildung
und Forschung

□ 60 T pulsed magnetic field coil (2023+ **HiBEF**)

cryogenic sample environment

HED – research at extremes

Laser Compression
Shock & ramp compression

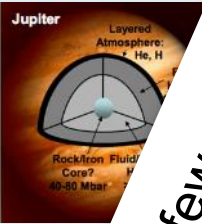

XRD, IXS, XES, XRF, X-ray microscopy

Long-pulse laser

Diamond Anvil Cells
Fast compression piezo DAC
Pulsed laser heated DAC
Two-stage DAC

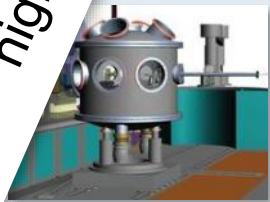

18 to 25 keV

Relativistic Laser-Plasmas
Electron transport
Instabilities and filamentation
Particle acceleration
High EM fields

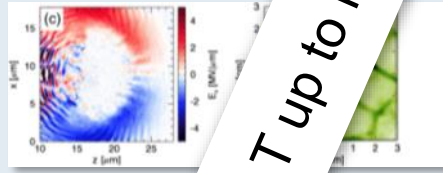

Multi-100 fs laser

Isochoric excitation
Transport properties,
Heat flows, rates

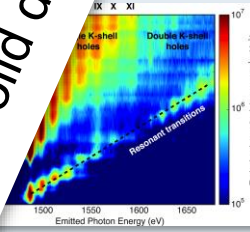

XES, IXS, XRD
Tight focusing

Advanced methods
Spectrometers
Advanced focusing
SAXS energy analyzer
Phase contrast imaging

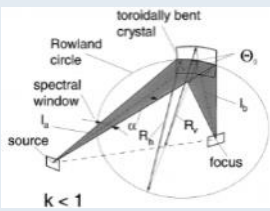

Further projects
Isobaric heating
Cryogenic jet targets
High-rep solids targets
EMP-hard X-ray detectors
High-purity polarimetry
Laser-shocked DAC
GISAXS

https://www.xfel.eu/facility/instruments/hed/



Home > Facility > Instruments > HED

Scientific Instrument HED

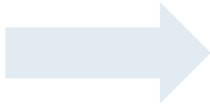

Take our virtual tour and look at the hutch!

Proposal preparation for the HED instrument

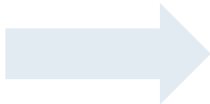

Call for Proposals - Frequently asked Questions and Answers



What is HED?

The High Energy Density (HED) scientific instrument is a new, unique platform for experiments combining hard X-ray FEL radiation

The conditions expected for this allocation period are listed below. **Nevertheless, case-by-case verification of specific feasibility conditions with the instrument groups is required.**

	Photon energy range	Expected pulse energy**
SA2	5.8–9.3 keV	2 mJ
	>9.3–12 keV	1 mJ
	>12–24 keV	0.5 mJ

Bunch distribution: 350 X-ray pulses per instrument assuming the equal distribution at 2.25 MHz. Higher or smaller numbers for higher/smaller intra-train frequency.
Max. 2250 electron bunches within 500 μ s at 4.5 MHz (only 1 week in the next run).

** Pulse energy depends on bunch charge, electron energy, and photon energy.

The above parameters correspond to the *standard* SASE operation mode.

The following *special* modes are available but require more tuning and are less reliable:

- Hard X-ray self-seeding (SA2; 7 - 14 keV)
- Hard X-ray two-colour w. variable delay (SA2; 6–10 keV; 0–0.5 ps)
- Short bunches (< 10 fs FWHM); requires coordinated scheduling as other instruments and available number of bunches might be affected; time-diagnostics is only partially available
- Full trains at instruments with \gg 10 Hz rep. rates (\sim max. 2250 pulses), e.g. for dDAC

Experiments requesting these *special* modes should address the development of new techniques and fields and are expected to involve large communities and facility staff. Since there is a vast range of detailed specifications for these special modes, proposers are requested to contact the corresponding instrument staff in order to clarify requirements.

Details on Special mode d: Full trains with $\gg 10$ Hz rep rates (up to ~ 2250 pulses)

- EuXFELs timing system is absolutely capable of this mode. However the various feed-backs and feed-forwards that are presently optimised for each beamline separately will have to work on a common setpoint.
- We tune for a 'compromise' working point that works for all SASEs, but would not reconfigure the linac for a single pulse every minute or so. So every SASE would operate with a not optimal working point all the time.
- As a consequence we estimate a systematic **about 30% less intensity at compared to the standard modes.**
- The accelerator would run normally, where each train would deliver a portion of the RF window to each SASE. Then, every few seconds, a full train (full RF window) would go ONLY to SASE2 (HED). This means that SA1 and SA3 would “miss” one train every minute.

Awareness – beam jitter

Our facility is still suffering from spatial drifts (on the timescale of minutes) and jitter (pulse-to-pulse) of the x-ray beam. It is dominantly in the horizontal direction (left-right). This occurs only sometimes and at unforeseeable times (no correlations with external events). The issue is complex and the root cause(s) not yet fully understood. We are working on solving this issue.



However, from the current perspective, we cannot guarantee that we will have implemented a solution at the time of allocation of your beamtime. Therefore, if your experiment is critically depending on a stable beam pointing, please **address mitigation scenarios** in your proposal, take into account that **more statistics** on your data will be needed, and make your experiment design **robust against beam jitter**.

This is work in progress - in case of specific questions, please inquire with the instrument scientists.

Some constraints

- The linac of EuXFEL has specific electron energy setpoints, 11.5, 14, and 16.3 GeV.
- At 11.5 GeV, the available photon energy range at SASE2 and HED is 5-9 keV, it can be extended to higher values but the intensity will drop significantly. Even at 8-9 keV, the pulse energies will probably not exceed 0.3 mJ. 14 GeV: ~6 - ~15 keV, 16.3 GeV: 8.2 – 25 keV, respectively.
- It is **not possible to change between 5-6 keV and 12-24 keV** during one user experiment because the electron energy is fixed for the entire facility.
- We **strongly recommend to not change the photon energy during your experiment**, or at least not more than 1 keV. Larger changes need extensive tuning time of the LINAC and undulators and may lead to a low technical feasibility ranking. Also the x-ray focusing needs to be changed and aligned after each change.
- The „**special mode**“ **two-color** (see slide 3) has been successfully used at HED in 2022, however interested proposers should contact HED staff with their specific request and HED would catalyze a discussion with experts feeling comfortable to discuss these. We feel confident to offer up to 100 μ J per color and pulse.

8th call for proposals

❑ We offer on a regular basis – X-RAY parameters:

- ❑ 5-24 keV x-ray photon energy SASE spectrum (about 0.2% bandwidth), usually about 1-2 mJ pulse energy in ~20-40 eV (before CRL lenses)
- ❑ Seeded x-rays between 8-14 keV (~1 eV spectral width), few 100 μ J

- ❑ Single pulses/trains on demand, or 10 Hz continuous
- ❑ pulse trains of 2.25 MHz (440 ns) or less (down to single pulse on demand)
- ❑ One week with 4.5 MHz rep. rate (222 ns)

- ❑ 4-bounce monochromator (1 eV bandwidth) at 10 Hz between 5-18 keV
- ❑ High res-mono@7.49 keV (about 40 meV bandwidth) at 10 Hz

- ❑ full focusing capability CRL 1,2,3,4
any focus from parallel beam (few μ rad divergence) down to sub- μ m foci, however with potentially significant absorption in the Be lenses. The feasibility of sub-micron foci at photon energies >9 keV have to be discussed with the instrument scientists beforehand.

- ❑ “HIREX2” spectrometer in the SASE2 branch (before the separation into MID and HED) for monitoring the incident SASE / seeded spectrum.

HED beam transport

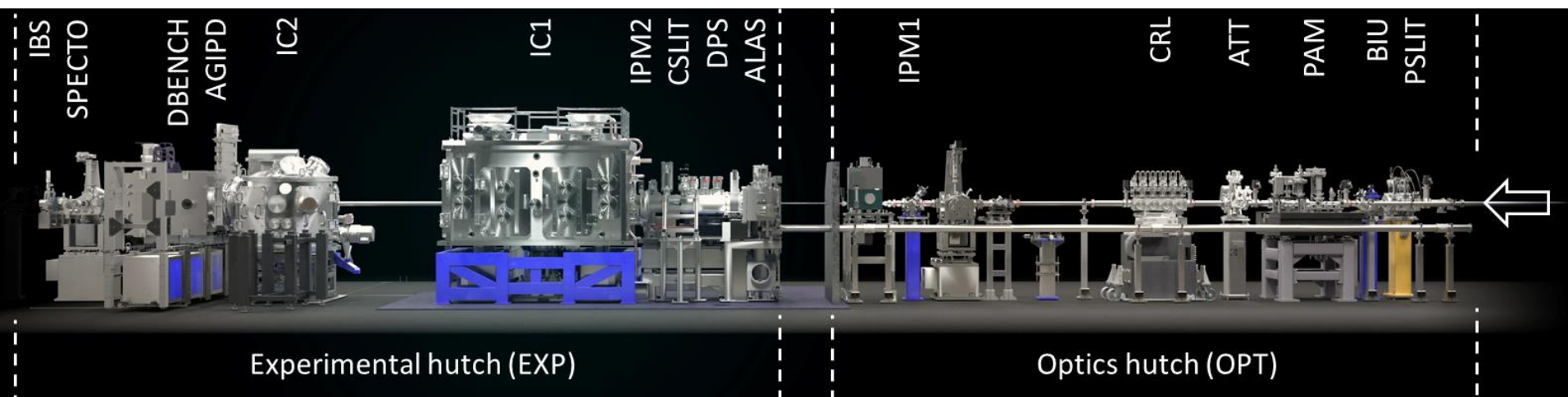

μm & nm focus CRL configuration

Talbot plane phase tuning, wavefront imaging

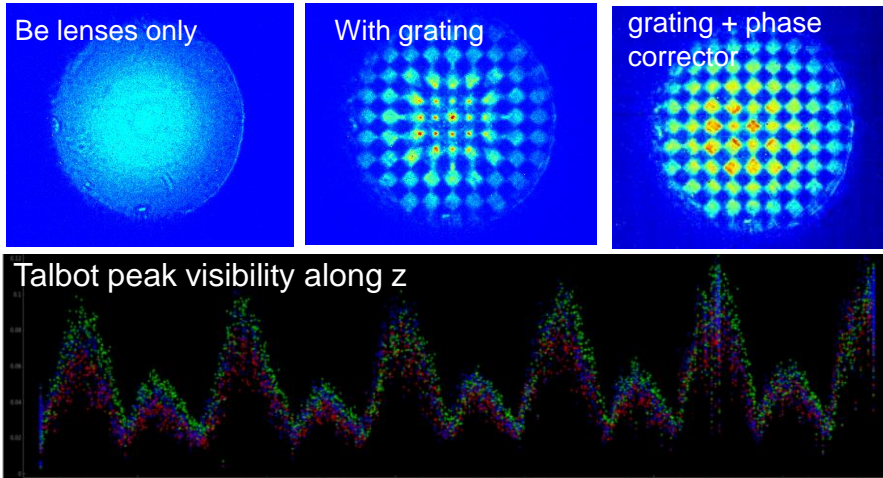

Ablation imprint: intensity > 10⁶ dynamic range

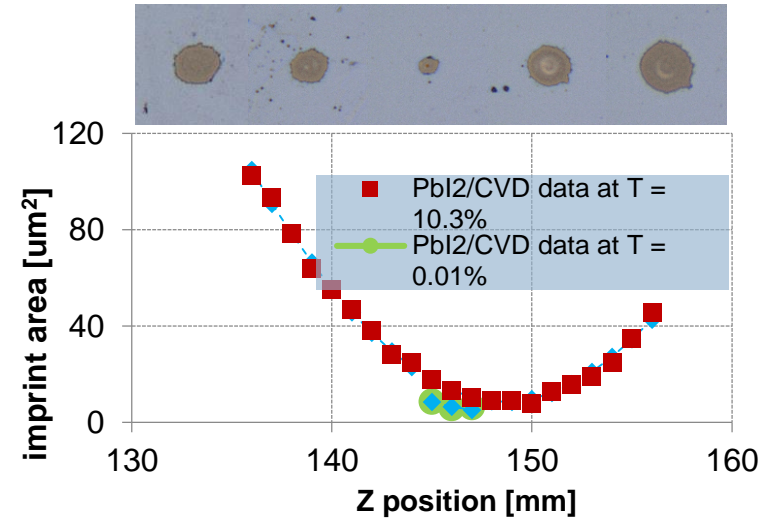

Ptychography with SASE mode

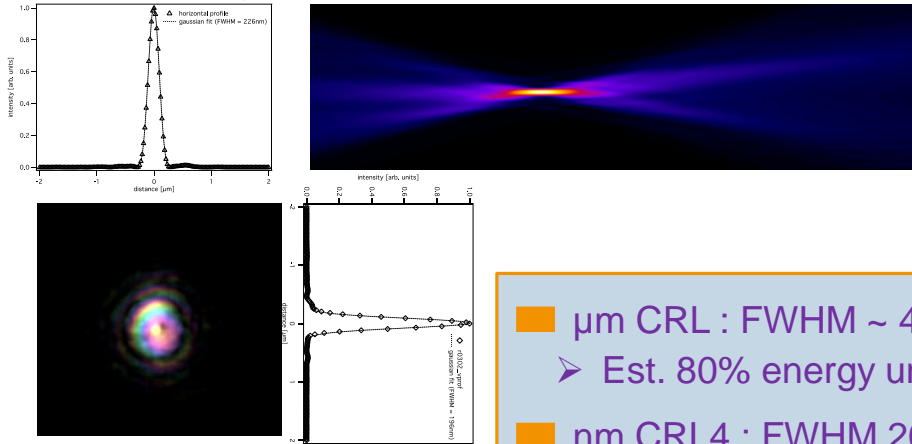

- μm CRL : FWHM ~ 4 μm
- Est. 80% energy under FWHM
- nm CRL4 : FWHM 200 - 350 nm

LiF : μm resolution lateral intensity profiling

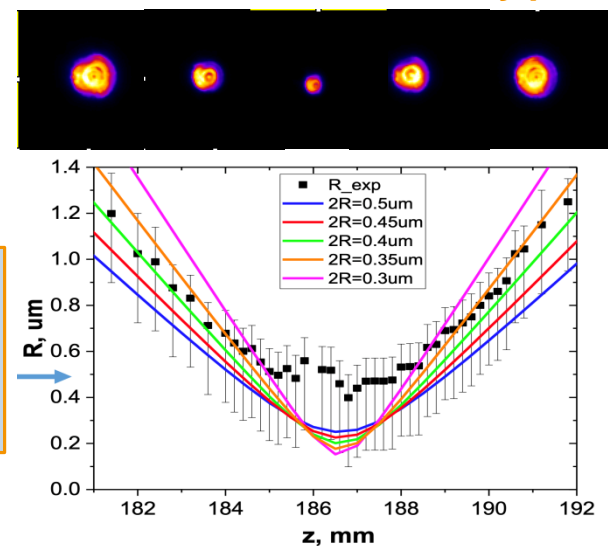

5x5 μm focus characterized

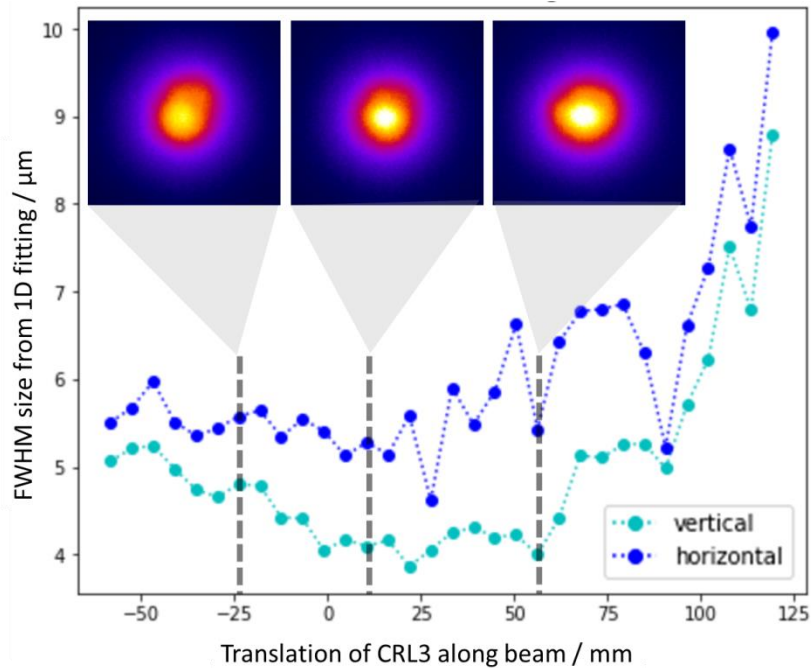

Focus in IC1 at 6.0 keV photon energy
by LiF imprints and post analysis

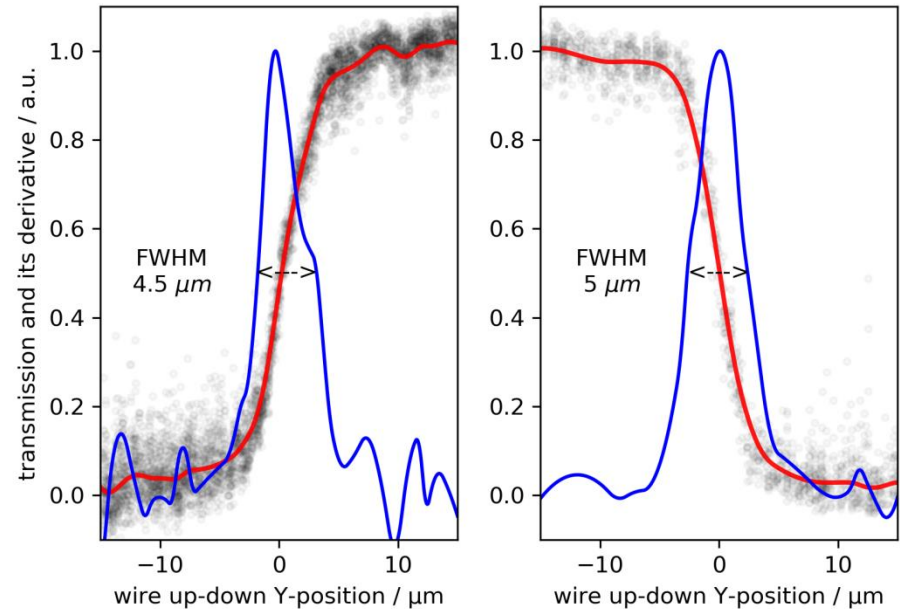

Focus in IC2 at 17.8 keV photon energy
by scannign with a 1 mm diam. W rod

Mosaic graphite von-Hamos spectrometer

- Inside IC1, we offer von-Hamos HAPG spectrometers for emission or scattering experiments. Please contact us for further details. A JINST publication is available: <https://doi.org/10.1088/1748-0221/15/11/P11033> .
Contact Thomas Preston for details.
- The spectrometers, equipped with Jungfrau detectors and tungsten shielding, have been successfully used for K-line spectroscopy in combination with RELAX shots at $I=10^{20}$ W/cm².

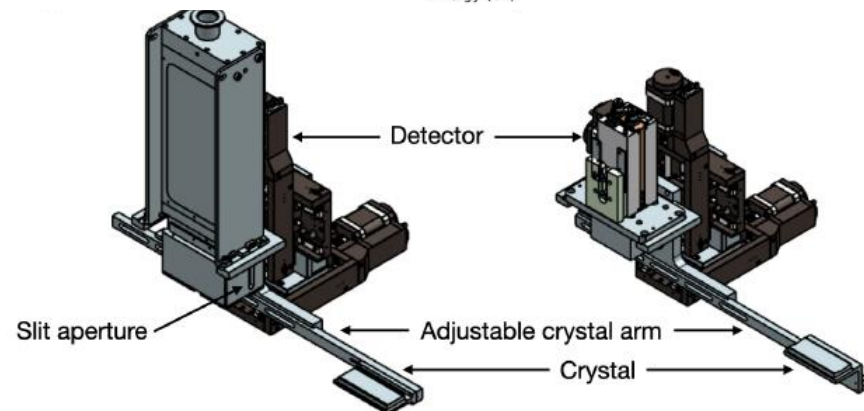
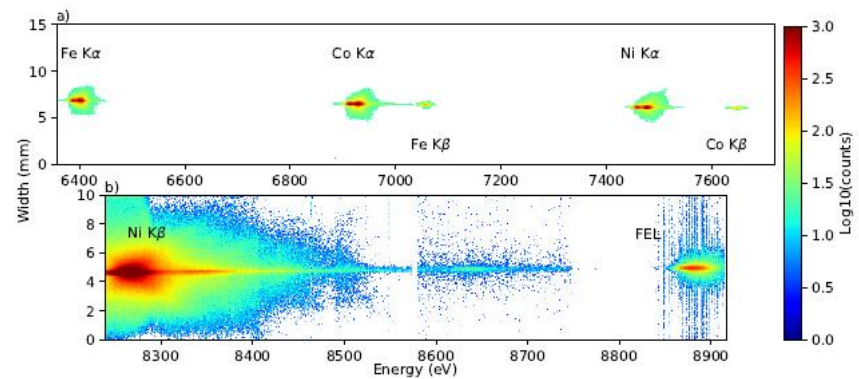
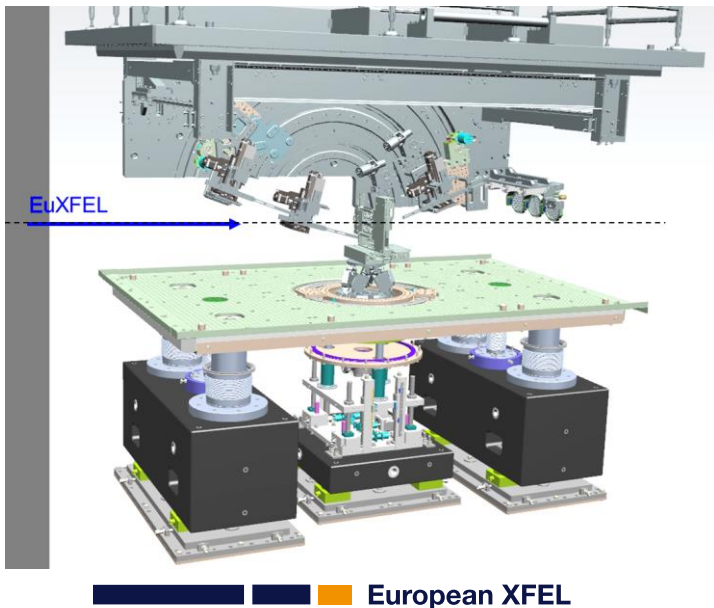

Optional devices which require R&D and heavy support

- ❑ bent diamond crystal spectrum analyzer downstream of the interaction.
Contact Karen Appel for details.
- ❑ AGIPD 500K detector (352 images at 3 gain stages with up to 4.5 MHz).
Contact Cornelius Strohm for details.

AGIPD 500K

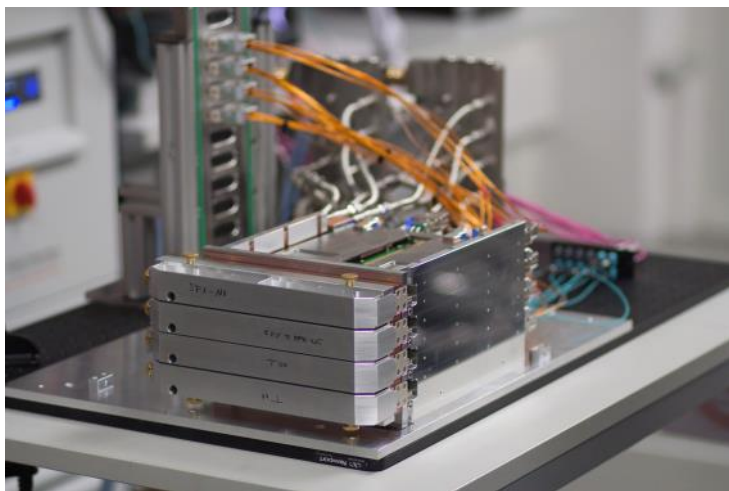

XRD standard on the AGIPD 500K at HED -
LaB6 at 17.8 keV

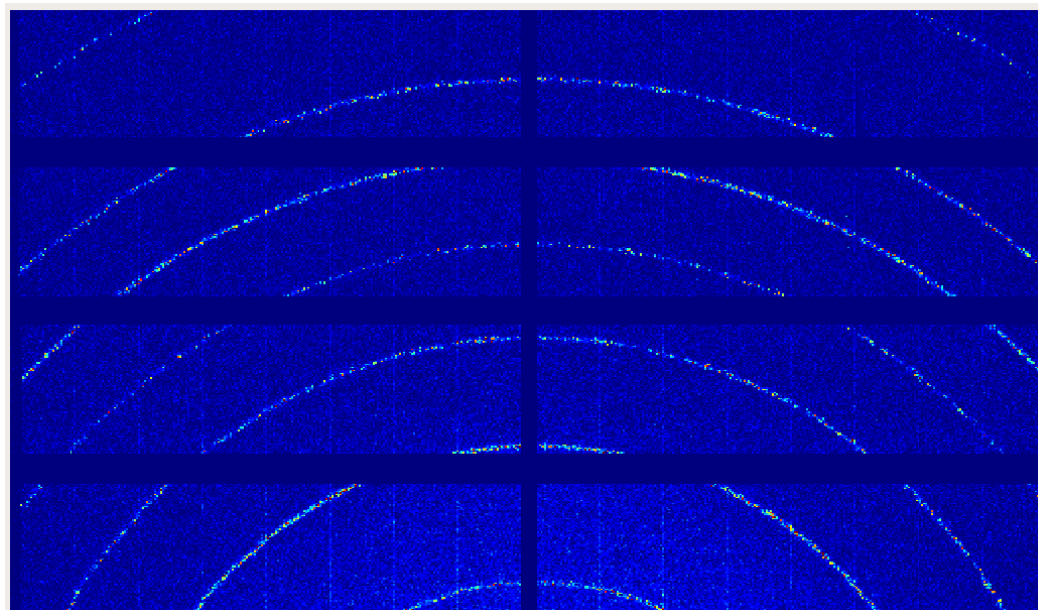

Platforms – Interaction Chamber 1

- 2 ePIX100 detectors for spectroscopy, imaging or XRD, 50um pixel pitch, ~700x700 pixels, 10 Hz. Very low noise
- 3x (vacuum) and 1 in-air JUNGFRU detectors (gain switching 10^4) at 10 Hz (**no** burst mode yet) for XRD or spectroscopy (pixel pitch 75um, detector size ~ 3.5*7 cm)

For details on detectors, please contact Thomas Preston from EuXFEL detector group.

- Possibility to mount area detectors or spectrometers on curved rails in vacuum on vertical breadboard
- Von-Hamos HAPG spectrometers (RoC 50mm and 80mm, crystals available 40um HAPG, 100um HAPG, 200um HOPG)
- High-resolution monochromator and diced analyzers (Si 533) for ~45meV spectroscopy at 7.490 eV
- stepper-motor target stage (10x10 cm area) on hexapod and precision rotation stage
- CRL4 for sub- μm foci

ePIX and JUNGFRAU

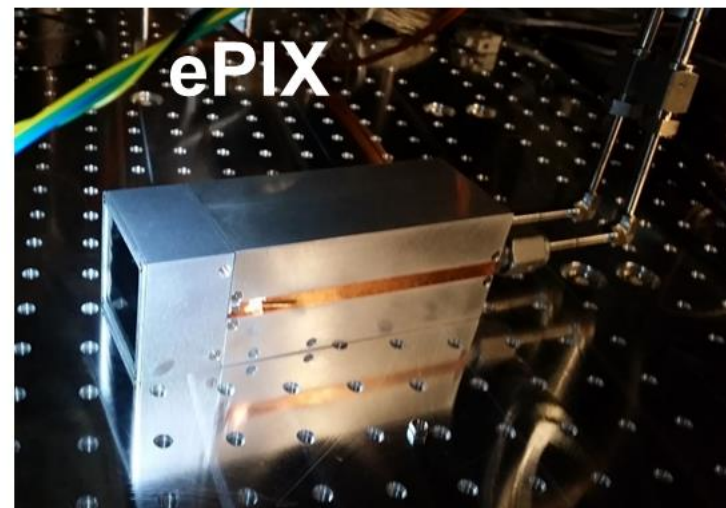

Name	Pixel size (μm)	No. of pixels (adim.)	Detection area (mm^2)	Noise (eV)	Frame rate (Hz)	Dynamic Range (photons per pixel)
ePix 100	50	704×768	35×38	< 280	120	10^2 8 keV
Jungfrau	75	512×1024	38.55×77.25	< 450	2400	10^4 12 keV

High res-IXS: Instrument function

Descamps et al., Scientific Reports 10, 14564 (2020)

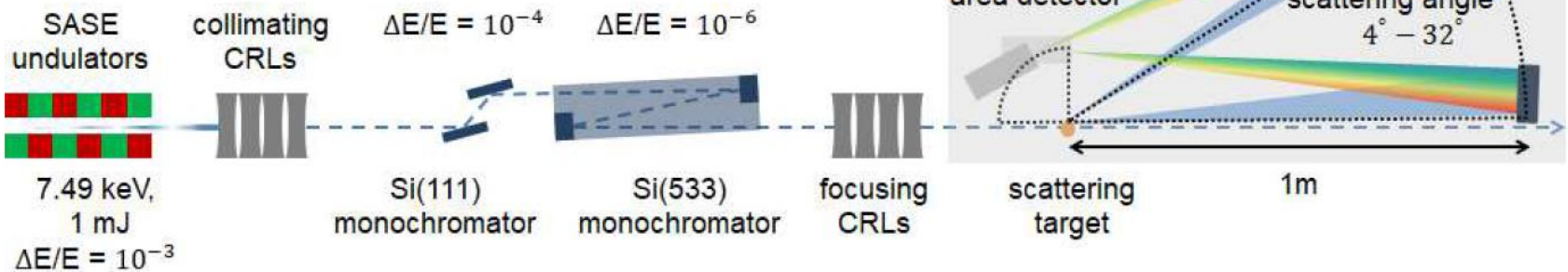

Thin samples yield close-to design spectral resolution

Descamps et al., Scientific Reports 10, 14564 (2020)

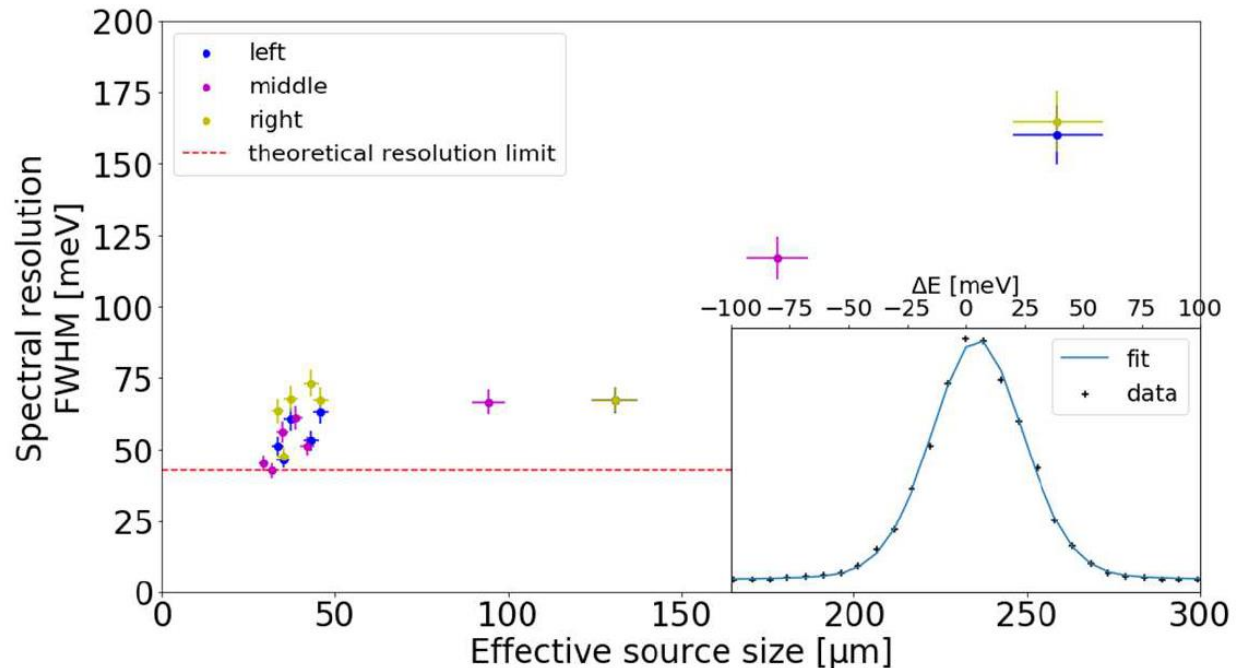

Platforms – Interaction Chamber 2

IC2

- Diamond Anvil Cell (DAC) setup for precision XRD
- 2 VAREX flatpanel detectors in IC2 (10 Hz)
- AGIPD mini-half 4.5 MHz detector
- Pulsed laser heating for DAC research
- Dynamic DAC (dDAC)

IC2:

a) outside

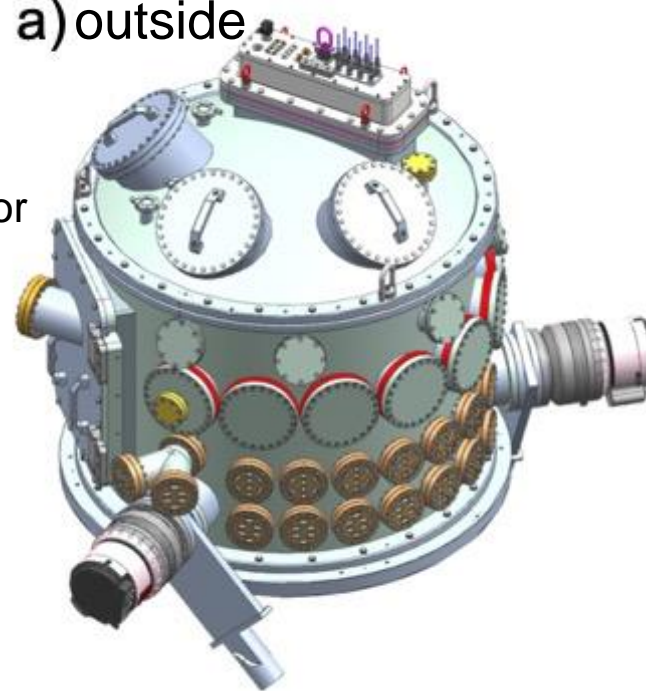

b) inside

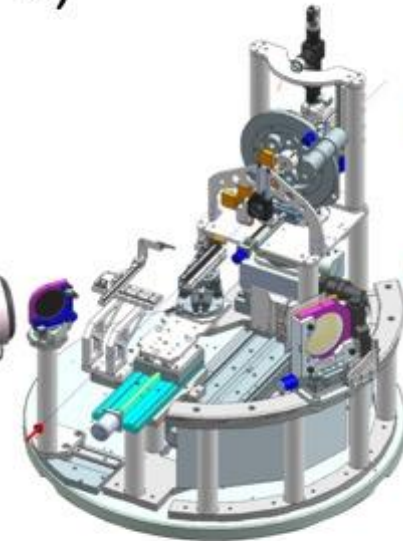

contact HED instrument scientists: *Zuzana Konopkova*,
or HiBEF UC members: *Cornelius Strohm*, *Rachel Husband*
for details of this platform

Pulsed Laser heating for DAC research

- double side laser heating in DACs
- 2x 100 W NIR lasers in pulse mode or cw mode.
Pulse duration 10-500 ns, and $>1 \mu\text{s}$ possible
- temperature determination: time resolved spectral radiometry (SOP) using streak camera system

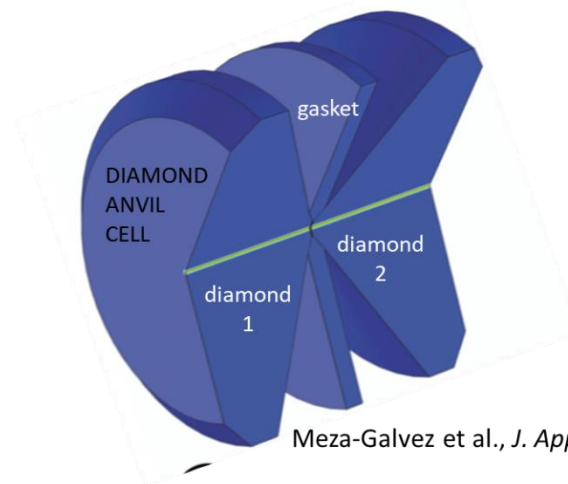
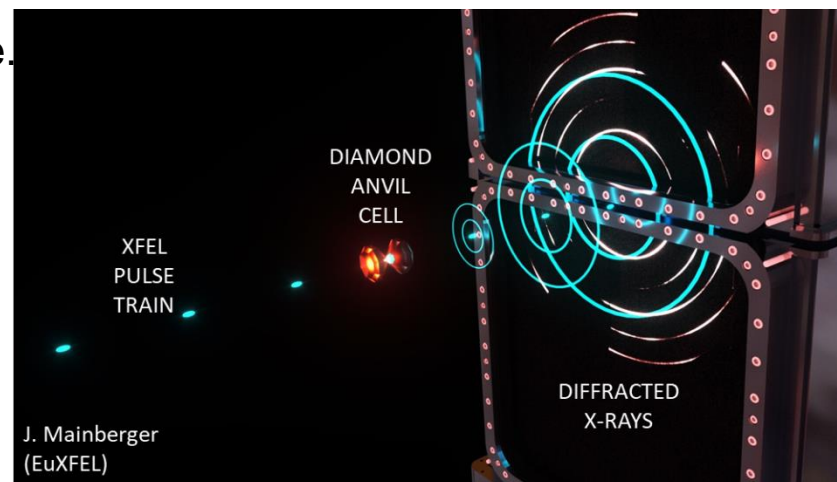

*For further information, please contact Zuzana Konopkova from the HED team:
zuzana.konopkova@xfel.eu*

Streak Optical Pyrometry (SOP) to measure thermal emission

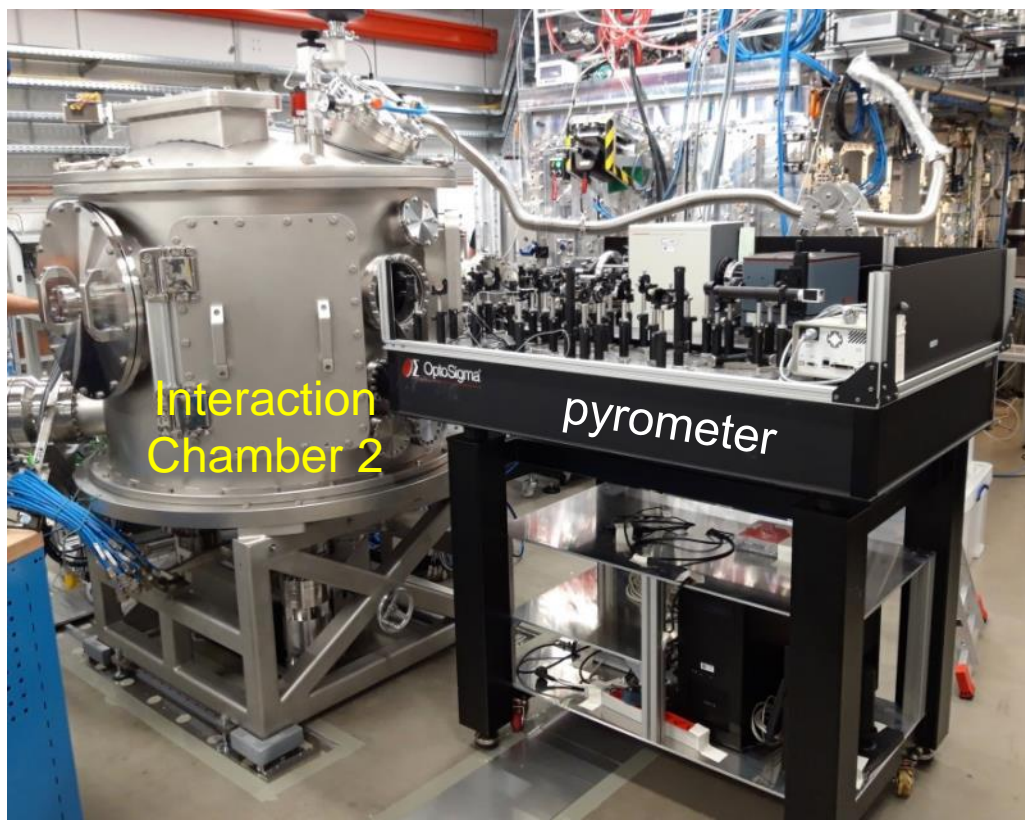

Streaked spectrogram

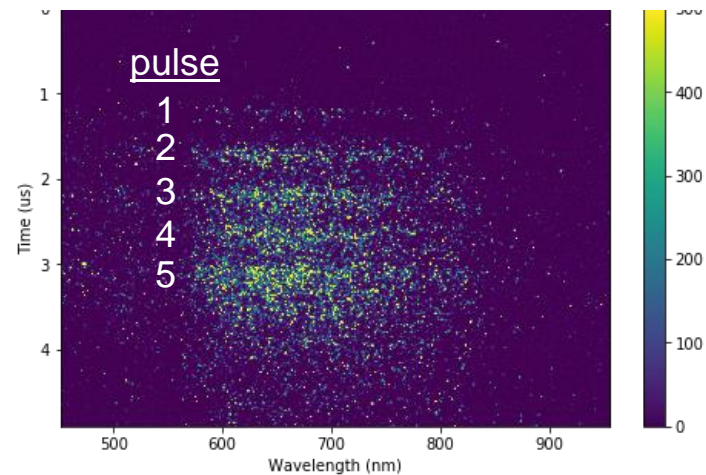

*For further information, please contact Zuzana Konopkova from the HED team:
zuzana.konopkova@xfel.eu*

Pump-probe (PP) laser

■ Anticipated parameters

■ PP laser at 800 nm wavelength

- ▶ < 20 fs duration, close to Fourier-limited bandwidth (going for narrower bandwidth with longer pulse duration is an option)
- ▶ 100 kHz, max ~2 mJ at 100 kHz, or down to 10Hz or shot-on-demand
- ▶ Higher repetition up to 4.5 MHz with lower pulse energy
- ▶ Second harmonic (400 nm) is available. Conversion efficiency is however low (15-20%) due to the large bandwidth.

■ PP laser at 1030 nm wavelength

- ▶ Duration: ~ 1 ps compressed or ~450 ps uncompressed.
- ▶ 100 kHz, max ~30 mJ at 100 kHz, or down to 10Hz or shot-on-demand
- ▶ Higher repetition up to 4.5 MHz with lower pulse energy
- ▶ Second/third harmonic (515/343 nm) are potentially available. Please contact us.

For more details contact Motoaki Nakatsutsumi and/or Jan-Patrick Schwinkendorf from the HED team: motoaki.nakatsutsumi@xfel.eu, jan-patrick.schwinkendorf@xfel.eu

Platforms – Interaction Chamber 2 + shock setup

IC2

Shock-setup in IC2

Can be coupled with 1030 nm pp-laser with ~450 ps duration (see slide 19)

Other possibilities (other pump laser sources) need to be discussed with instrument scientists before submission.

Only for highly competitive proposals due to significant setup time.

IC2

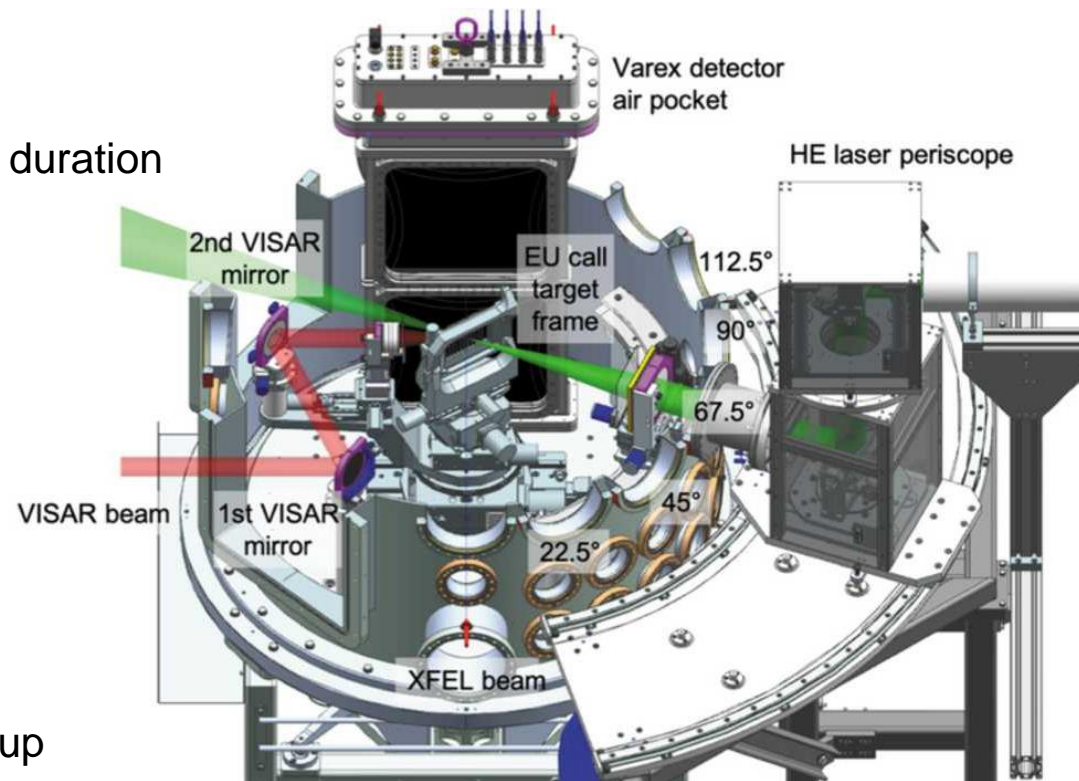

Platforms – Interaction Chamber 2 + shock setup + DIPOLE

“Dynamic laser-compression platform”

Proposals for DiPOLE **ONLY** in this standard configuration
(more complex proposals will be possible in future calls)

> EU call HIREP frame

- Experiments in IC2 chamber with shock setup
- Geometry: the quasi-collinear shock geometry (22.5° between shock direction and x-rays) will be commissioned, however 90° between laser drive and x-rays may be proposed, but requires a setup change and commissioning time (please account for it in your proposal).
- DiPOLE 100-X laser at 2ω , focus on target with $250\ \mu\text{m}$ or $500\ \mu\text{m}$ phase plate
- 2ω laser energy: temporal square pulse scales as currently expected: ca. 50 J in 10 ns, ca. 15 J in 2 ns.
- pulse shaping (other than flattop) on best-effort basis, contained energy has to be evaluated and will be lower than in a square pulse.
- X-ray diagnostics: XRD with VAREX at 18 keV x-ray photon energy, SASE
- Optical diagnostics: VISAR (1 arm 1064nm and 2 arms 532nm) plus 1 SOP arm.

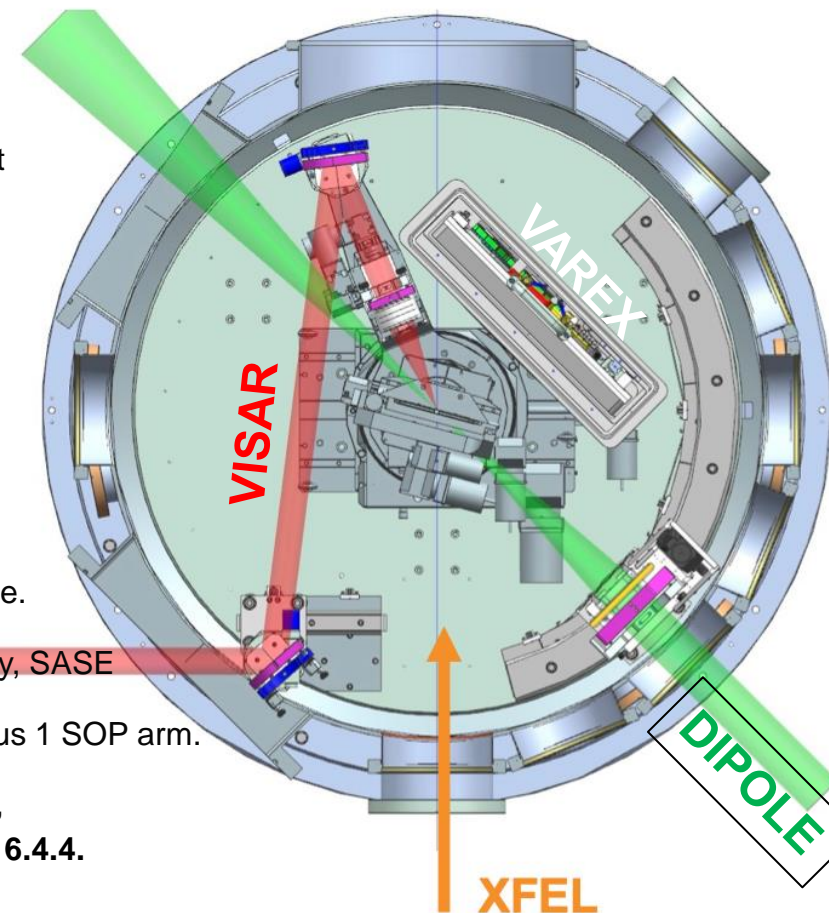

For more details, refer to Zastrau et al., J. Synchrotron Rad. (2021). 28, 1393–1416, **chapter 6.4.2, figure 20 and 21, and for VAREX chapter 6.4.4.**

HI-OL: HiBEF ReLaX TW laser

There is a publication about the performance of this laser:

High Power Laser Science and Engineering

A. Laso Garcia et al., High Power Laser Science and Engineering (2021) - <https://doi.org/10.1017/hpl.2021.47>

Further questions about the laser can be directed to Toma Toncian, t.toncian@hzdr.de

HI-OL Laser parameters:

- up to 100 TW laser beam available at IC1 target chamber.
- Laser pulse duration <30 fs (nominal).
- Energy up to 3 J on target.
- Irradiation geometry: 45 deg to X-ray axis and target normal.
- F/2 focusing optic.
- Laser wavelength 750-850 nm.
- Arrival jitter compared to x-rays at IC1 <30 fs RMS.
- a synchronized optical probe beam with mJ energy can be made available upon request.
- on shot diagnostic package with NF, FF, WF, pulse duration, arrival time at PAM.
- latest laser contrast trace can be measured upon request.
- Shot-on-demand experiments (other modes upon request).

Shot rate will be limited by alignment time, debris issues, and probationary radiological limits.

For further details, contact Toma Toncian: toma.toncian@xfel.eu

HI-OL: HiBEF ReLaX TW laser

X-ray diagnostics:

- X-ray spectrometers (HAPG)
- Small angle scattering (SAXS) setup
 - angular range covered: 1.7-19 mrad
 - indirect FOV imaged with Highly Oriented Pyrolytic Graphite Crystals with an accepted x-ray bandwidth optimized for 8.15 keV
- Focusing setup (CRL3)
 - direct FOV: $100^2 \mu\text{m}^2$ to $1000^2 \mu\text{m}^2$
- Sub- μm focus with CRL4
 - If you need sub- μm focus, please contact the instrument scientist prior to the proposal submission
- Downstream CRLs (dsCRL) for imaging purposes

Non X-ray diagnostics can be provided if needed:

- Thomson Parabola with an energy range .5- 40 MeV for p+
- electron spectrometer
- Bremsstrahlung spectrometer with an energy range up to 20 MeV

"Other diagnostics (e.g. optical probe such as FDI) can be discussed and integrated in the proposal upon request if feasible."

Typical setup at IC1 combining ReLaX with SAXS, PCI and spectroscopy

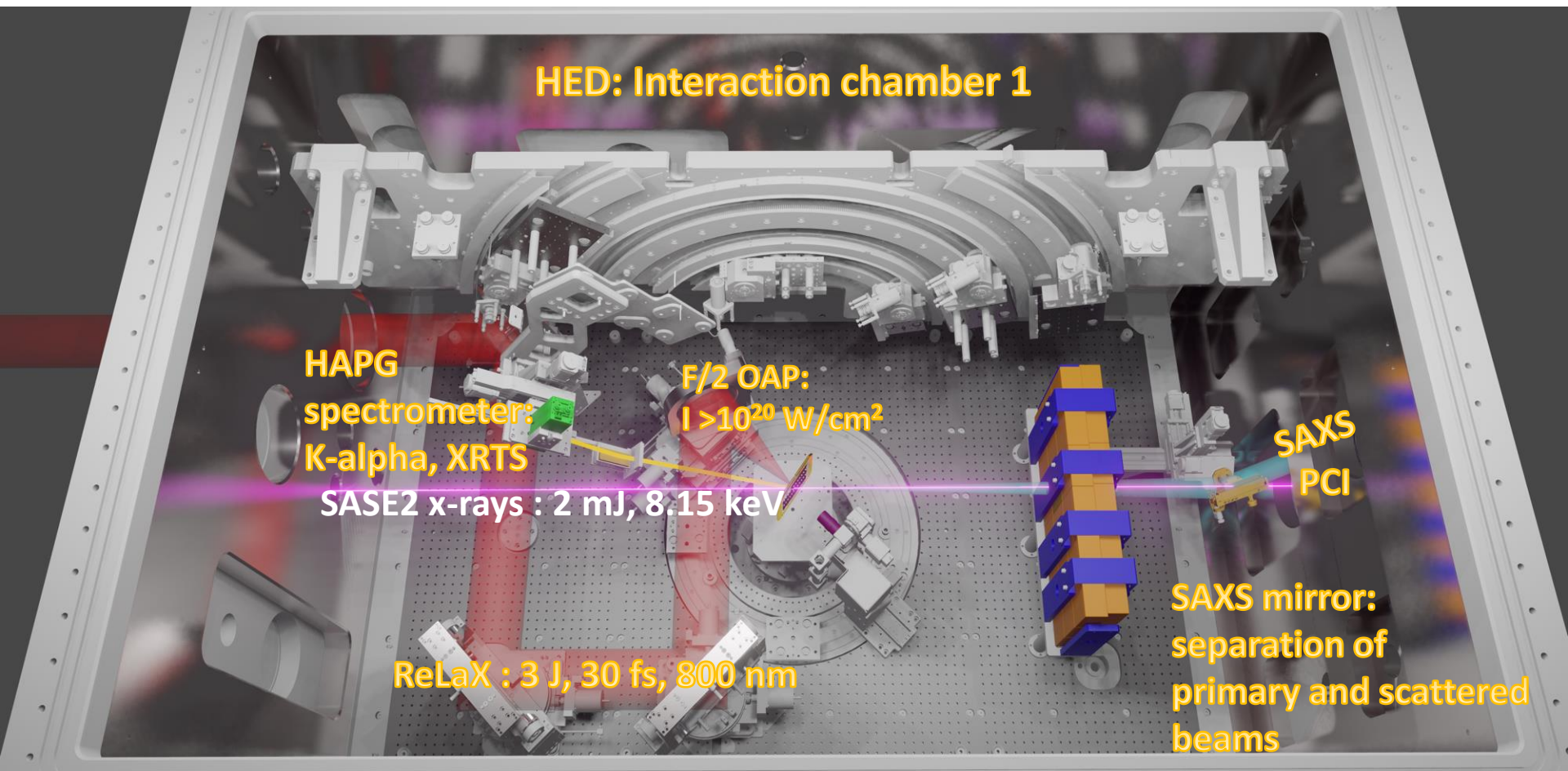

Pulse-to-pulse arrival jitter between x-ray and optical lasers is 20-30 fs

Pump-probe laser

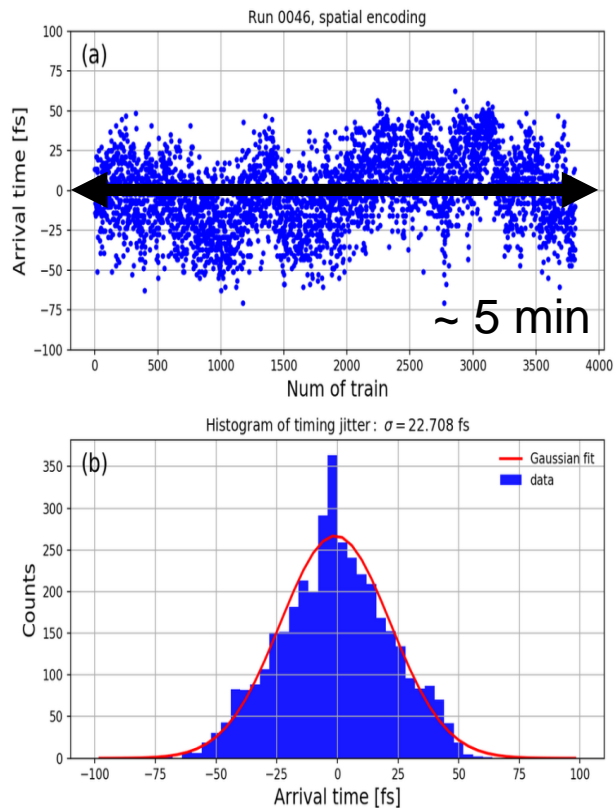

ReLaX TW laser

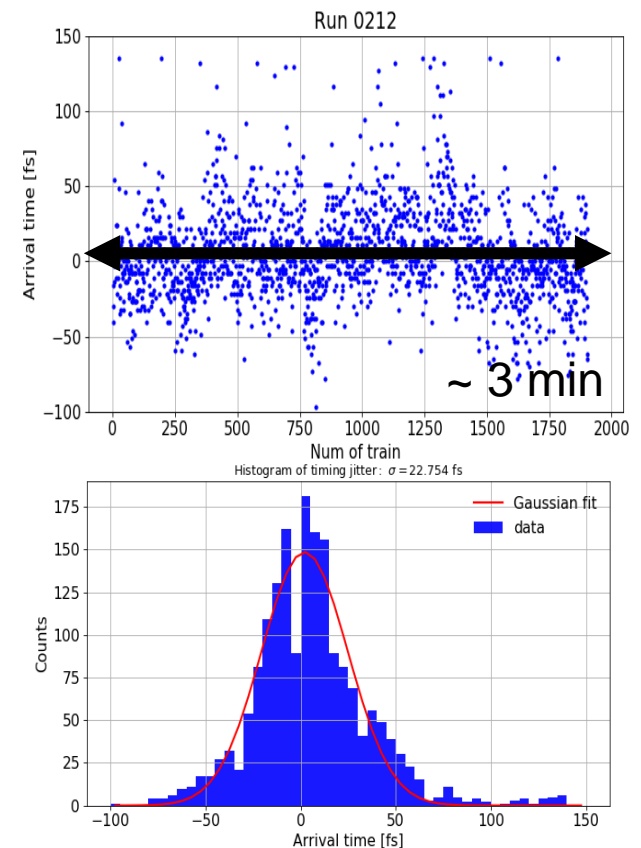

Possible experiments

Scientific drivers:

- Isochoric heating (using the focused intense XFEL pulse to create a plasma)
- Diamond anvil cells (incl. a standard configuration)
- Pump-probe laser (PP)
- 100 TW laser RE.LA.X (incl. a standard configuration)
- DiPOLE 100-X (**only** in a standard configuration)

Please contact the instrument staff for detailed information and PRIOR to proposal submission.

We offer **Standard configurations
(see next slide – about 2x higher chance to get scheduled)**

All proposals must be submitted through UPEX (<https://in.xfel.eu/upex>)

Three standard configurations (allows to schedule more experiments back-to-back)

Diamond Anvil Cell (DAC) standard configuration

- IC2 standard DAC setup, symmetric DAC cell support for users who need cells. user supplied BX90 with adapters.
- optical observation microscope, streaked pyrometry for x-ray heating.
- 18 keV SASE, max rep rate 4.5 MHz, > 0.5 mJ pulse energy from the undulators (not accounting for beamline transmission)
- 5-15 micrometer focal spot size (fixed at 5 μm , but effectively larger depending on beam pointing stability)
- Detectors: AGIPD mini-half detector and VAREX flatpanel
- Requirement to contact HED instrument team for feasibility check.

ReLaX-SAXS-PCI standard configuration.

- IC1 chamber, 100 TW ReLaX laser incident on target at 45° w. r. t. XFEL (no normal incidence of laser on target)
- SAXS+PCI @ 8.15 keV SASE (tunable within reasonable range), ca. 1 mJ per pulse, 2.25 MHz maximum rep rate.
- + 5-50 μm spot size (both X-ray and ReLaX)
- + PCI resolution of about 1 μm
- Backward HAPG x-ray spectrometer. Forward spectrometer can only be added if SAXS diagnostics is not used.
- Laser diagnostics (upon request): EMP, electron, bremsstrahlung and proton diagnostics (contact HED staff for details before submission).

DiPOLE 100-X standard configuration

- • Experiments in IC2 chamber with shock setup
- • Geometry: the quasi-collinear geometry will be commissioned, however 90° between laser and x-rays may be proposed, but requires a setup change and commissioning time (please account for it in your proposal).
- • DiPOLE laser at 2w, focus on target with 250 μm or 500 μm phase plate
- • 2w laser energy: temporal square pulse scales as currently expected: ca. 50 J in 10 ns, ca. 15 J in 2 ns.
- • pulse shaping (other than flattop) on best-effort basis, contained energy has to be evaluated and will be lower than in a square pulse.
- • X-ray diagnostics: XRD with VAREX at 18 keV x-ray photon energy, SASE
- • Optical diagnostics: VISAR (1 arm 1064nm and 2 arms 532nm) plus 1 SOP arm.

Instrument papers

■ General overview of the HED instrument

■ Zastrau, Appel, Baehetz et al.,

J. Synchrotron Rad. (2021). 28, 1393–1416

■ Diffraction from Diamond Anvil Cells - overview

■ Liermann et al., J. Synchrotron Rad. (2021). 28, 688-706

■ ReLaX: the HiBEF high-intensity short-pulse laser driver

■ A. Laso Garcia et al., High Power Laser Science and Engineering (2021)

- <https://doi.org/10.1017/hpl.2021.47>

■ Design and performance of the HAPG von-Hamos spectrometers

■ Preston et al., Journal of Instrumentation, Volume 15 (2020)

■ Design and performance of the meV high resolution setup

■ Wollenweber et al., Review of Scientific Instruments 92, 013101 (2021)

■ Design and performance of the SAXS HAPG mirror

■ Smid et al., Review of Scientific Instruments 91, 123501 (2020)